

ALUMINUM
Fence Systems
Lifetime Warranty



Aluminum Fence Systems



Gates & Hardware



The Morgan Series Aluminum Fence System is manufactured of the highest quality aluminum and all parts of the system are powder coated for durability. The series has a “no screw” assembly process for easier installation. The Morgan Series can be used for residential, pool and commercial properties and is designed to keep its attractive appearance for years. This system is shipped in pre-assembled sections for your convenience.

The Morgan Aluminum Fence System consists of two series: 2000 and 4000.

The 2000 Series is recommended for residential installations and is constructed in six foot assembled sections, in various sizes. Hidden picket fasteners (patent pending) produce a clean, smooth profile and gates are available for each style. Optional are three finial choices, short pickets and ring assembly, shown on the following pages.

The 4000 Series is intended for commercial and heavy duty residential installations. Constructed in eight foot assembled sections, the 4000 Series comes in a variety of styles with matching gates. Designed with heavy posts and pickets with hidden fasteners for a clean appearance, every fence installation has a professional look. Special options for the 4000 Series include three finial choices, short pickets and ring assembly.

Arch top gates are available in all styles.

Lifetime Warranty

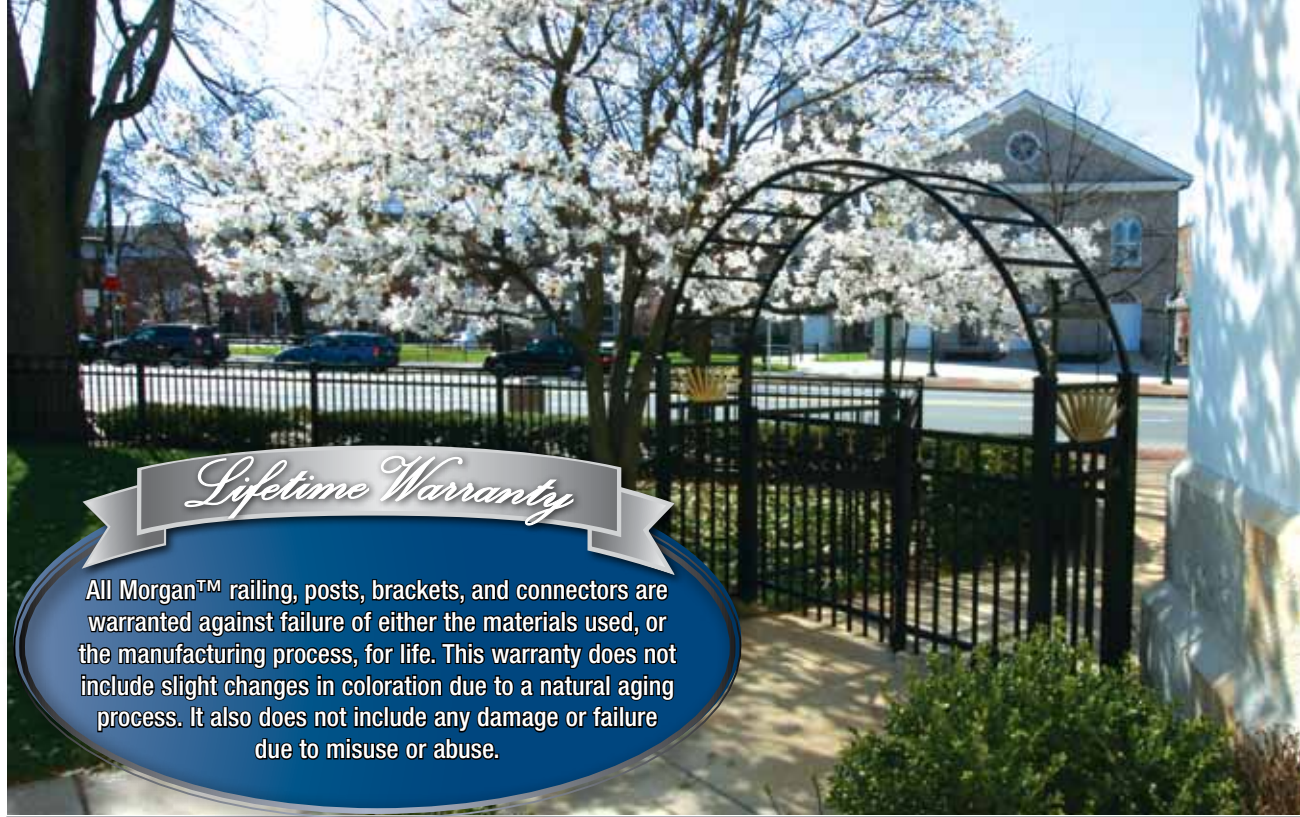

Lifetime Warranty

All Morgan™ railing, posts, brackets, and connectors are warranted against failure of either the materials used, or the manufacturing process, for life. This warranty does not include slight changes in coloration due to a natural aging process. It also does not include any damage or failure due to misuse or abuse.

Table of Contents

| | |
|-----------------------|-----|
| Gates & Hardware | 1 |
| Morgan Accessories | 1 |
| 4000 Series | 2-3 |
| 2000 Series | 4-5 |
| Custom Driveway Gates | 6 |

Post Cap Options



Trim Ring

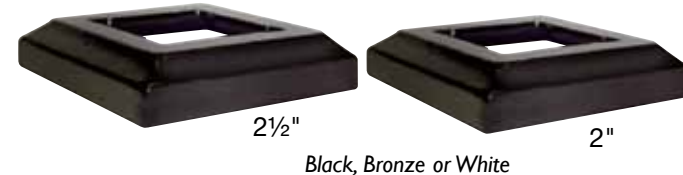

Gates & Hardware

Black
and White
In Stock



Self-Closing Gate Hinges
Available in regular or heavy duty approx. 3¾" high



Regular Multi-Adjust Hinge
Available in regular or heavy duty approx. 3¾" high



Lock-Latch Deluxe
Can be keyed to fit your house keys approx. 6¾" high



Magna Latch
Pool code approved



Optional Gate Handle
approx. 5" high



Lockable Gate Latch
approx. 6" high



Optional Kit
External Access Kit
Lockable Push-Button operates latch from outside the fence.



Solar Light or Low Voltage Light
2" or 2½"
Black, Bronze or White



Concrete Bracket
All Stainless Steel Post Bracket
An all stainless steel heavy-duty post bracket facilitates installations on almost any surface, especially concrete, when properly installed.
2½" or 2"



Spray Paint Can
Spray Paint Pen
Black, Bronze or White



Swivel Wall Mount
Black, Bronze or White
Specify Series (4000 or 2000)



Post Stiffener for
2" sq. post
2½" sq. post



Wall Mount
Black, Bronze or White
2000 Series Only

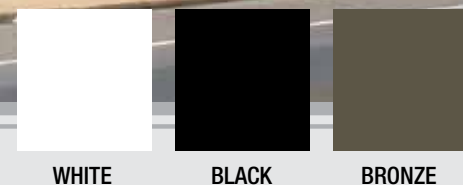

4000 Series

COMMERCIAL OR HD RESIDENTIAL



Matching Gates (special width available)
Arch Top Gates Available for 4000 Series

4000 Series Features:

- Finial Choices Available for Several Styles: Spear, Quad or Triad
- 8' on Center - Assembled Sections
- No Screws
- Racks - 8" in 8' Sections
- Powder Coating - AMAA 2604 Super Durable T.G.I.C. Powder Coated
- Hidden Picket Fasteners (patent pending)
- Heavy Posts - 2 1/2" X 2 1/2"
- Heavy Pickets - 3/4" X 3/4"

- Designer Series Posts and Rails
- Ring Assemblies (optional)
- Available Colors - Black Bronze or White - Most Styles in Stock
- Picket Spacing - 3.963"
- Short Picket Option for all styles
- Selections with Concave, Convex, and 2 Rail with Loop Option 4100 Series only

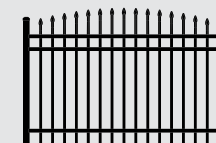
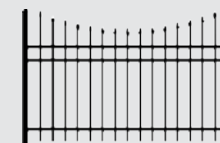
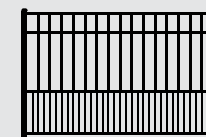

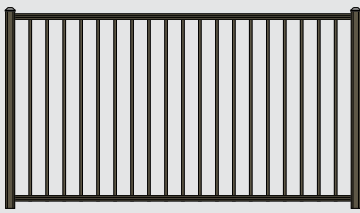

4048, 4054 Fence

Gates available in 3', 4' and 5' widths.

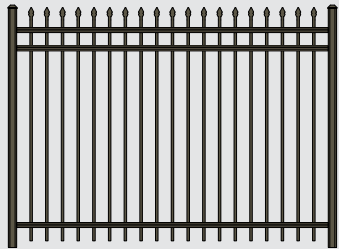

Finial Options

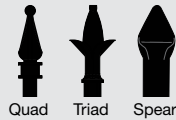

Quad Triad Spear

Ring Option

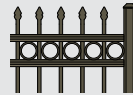

4148, 4160, 4172 Fence

Gates available in 3', 4' and 5' widths.

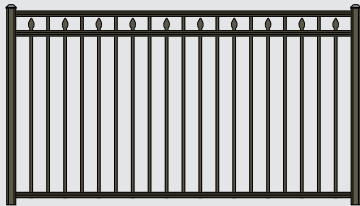

Finial Option



Spear

4254 Fence

Gates available in 3', 4' and 5' widths.

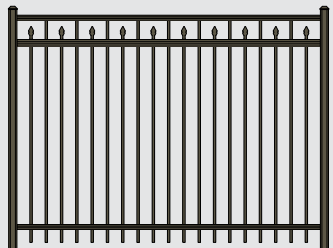

Finial Options

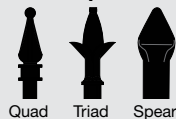

Quad Triad Spear

4248, 4260 Fence

Gates available in 3', 4' and 5' widths.

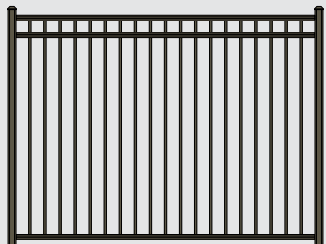

Ring Option

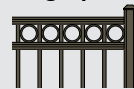

4354 Fence

Gates available in 3', 4' and 5' widths.

Pool Codes & Heights

| Model | Pool Code | Heights | | | | |
|-------|-----------|---------|-----|-----|-----|-----|
| | | 36" | 48" | 54" | 60" | 72" |
| 4048 | | | ● | | | |
| 4054 | | | | ● | | |
| 4148 | | | ● | | | |
| 4160 | | | | | ● | |
| 4172 | | | | | | ● |
| 4248 | | | ● | | | |
| 4254 | | | | ● | | |
| 4260 | | | | | ● | |
| 4348 | | | ● | | | |
| 4360 | | | | | ● | |
| 4336 | | ● | | | | |
| 4354 | | | | ● | | |

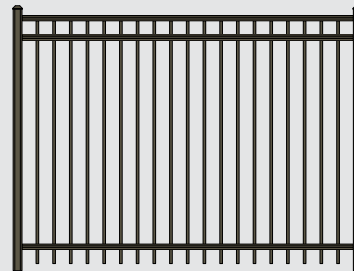

Ring Option

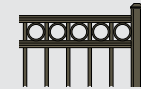

4336, 4348, 4360 Fence

Gates available in 3', 4' and 5' widths.

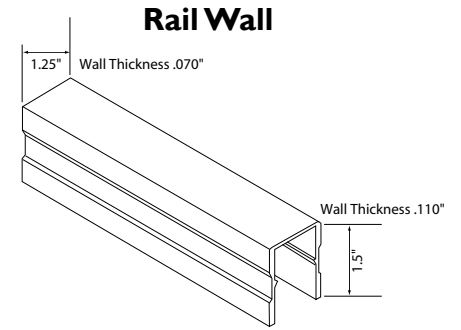

Post Wall

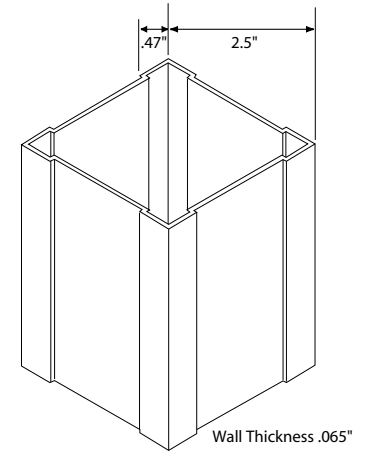

Double Picket Clip

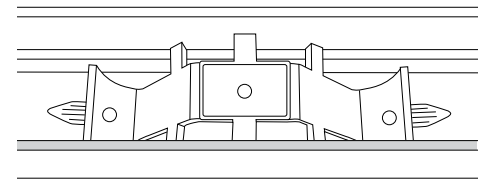

- **Unique Packaging...**
Each section is stacked vertically to reduce damage and is sleeved in heavy plastic to eliminate scratching.

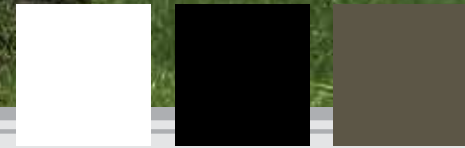

WHITE BLACK BRONZE

2000 Series

RESIDENTIAL



Matching Gates (special width available)
Arch Top Gates Available for 2000 Series

2000 Series Features:

- Finial Choices Available for Several Styles: Spear, Quad or Triad
- 6' on Center - Assembled Sections
- Powder Coating - AMAA 2604 Super Durable T.G.I.C. Powder Coated
- Hidden Picket Fasteners (patent pending)
- Picket - 5/8" X 5/8"
- Picket Spacing - 3.79" between pickets
- Designer Series Rails
- Racks - 12" in 6' Section
- Ring Assemblies (optional)
- Available Colors - Black, Bronze or White - Most Styles in Stock
- Short Picket Option for all styles
- Selections with Concave, Convex, and 2 Rail with Loop Option 2100 Series only

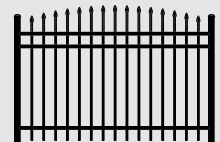
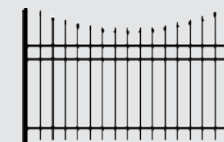
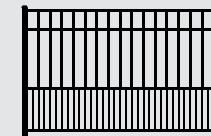

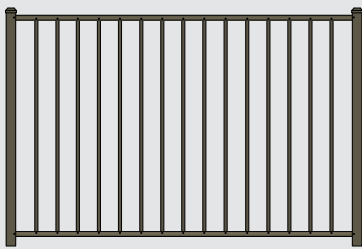

2048 Fence
Gates available in 3', 4' and 5' widths.

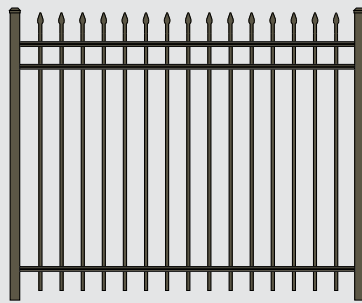

2148, 2160 Fence
Gates available in 3', 4' and 5' widths.

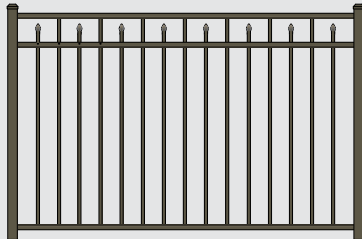
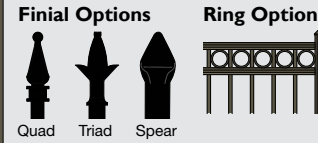

2254 Fence
Gates available in 3', 4' and 5' widths.

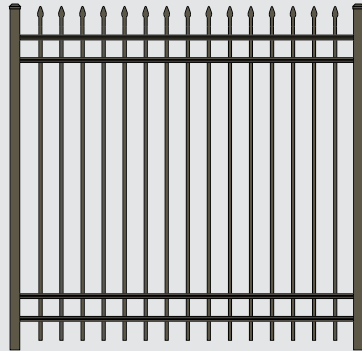
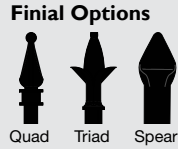

2172 Fence
Gates available in 3', 4' and 5' widths.

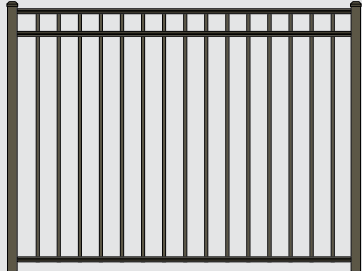
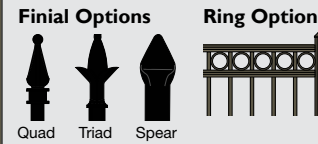

2354 Fence
Gates available in 3', 4' and 5' widths.

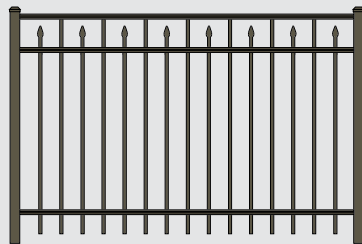
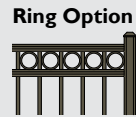

2248, 2260 Fence
Gates available in 3', 4' and 5' widths.

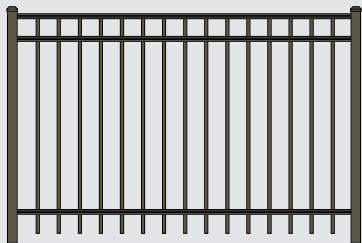
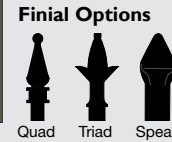

2336, 2348, 2360, Fence
Gates available in 3', 4' and 5' widths.

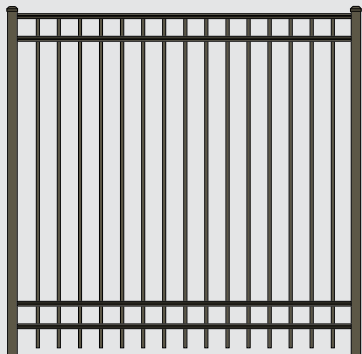

2372 Fence
Gates available in 3', 4' and 5' widths.



Pool Codes & Heights

| Model | Pool Code | Heights | | | | |
|-------|-----------|---------|-----|-----|-----|------|
| | | 36" | 48" | 54" | 60" | 72"* |
| 2048 | | | ● | | | |
| 2148 | | | ● | | | |
| 2160 | | | | | ● | |
| 2172 | | | | | | ● |
| 2248 | | | ● | | | |
| 2260 | | | | | ● | |
| 2254 | | | | ● | | |
| 2336 | | ● | | | | |
| 2348 | | | ● | | | |
| 2354 | | | | ● | | |
| 2360 | | | | | ● | |
| 2372 | | | | | | ● |

*72" Fence is constructed with 4 rails

Rail Wall

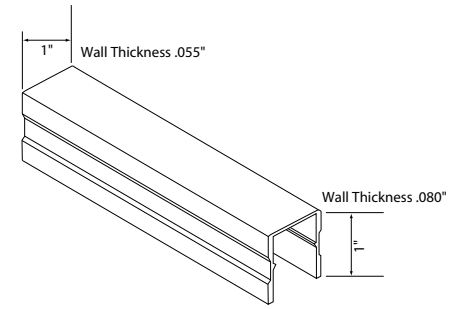

Post Wall

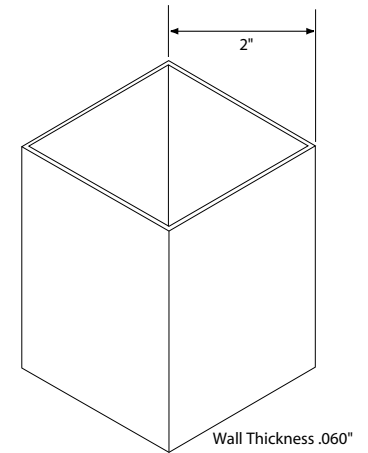

- **Unique Packaging...** Each section is stacked vertically to reduce damage and is sleeved in heavy plastic to eliminate scratching.



Custom Driveway Gates

Custom residential and commercial gates are available to your specifications, in swinging or sliding profiles.



AUTOMATIC GATE OPENER SYSTEMS FROM

Zareba™ & Eagle™

Other accessories available for your gate opening system.

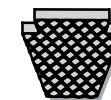

Key-Link

Fencing & Railing, Inc.

a division of Superior Plastic Products, Inc.

Quality, Our Key Link To Serving You!

150 Orlan Road • New Holland, PA 17557

888-704-7130 • Fax: 717-355-7139

www.keylinkfencing.com